

Comply and compatible with 19 inch international standard, metric system & ETSI standard. Welded structure, stable, static loading capacity 60 kg.

Product Description

Product Type	Single Door Wallmount Rack
Product ID	WIP6015S
Size	12U
Weight	± 29 kg
Dimension (DxWxH)	600 x 600 x 780 mm
Complete Set with	<ul style="list-style-type: none"> • Perforated Front Door and 2 Side Door with lock • 1 Unit Horizontal PDU 6 outlet with switch • 1 Unit Single Fan 220VAC • 1 pc Top Brush Panel • 4 pcs Dynabolt 88mm • 20 set M06 (Cagenuts & Screws)

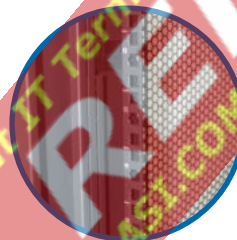

Product Drawing

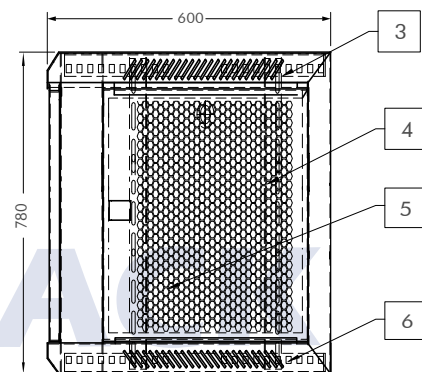
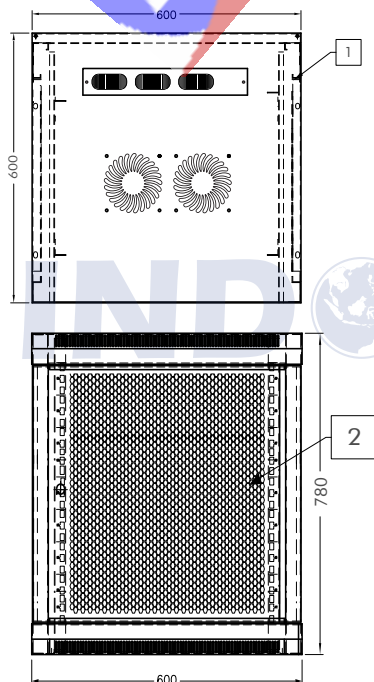

1. Frame
2. Front Door
3. Top, Bottom, Back Panel
4. Mounting Angle
5. Side Door
6. Mounting Profile



- A** Removable Side Door
- B** L Tower Bolt Lock Side Door
- C** L Tower Bolt Lock Inside

Quick and easy wall mounted 19 inch standard installation inside. Open angle for front and side door is over 180 degrees. Removable lockable side door, with L tower bolt lock side door and inside, cable entry from top and bottom.



Product Drawing

